

Hypertherm[®]

XPR300[™]

Unmatched performance. Unbeatable operating cost.





Contents

- 4 XPR overview
- 6 Industry leading X-Definition cut quality
- 10 Optimized productivity and reduced operating costs
- 12 Engineered system optimization
- 14 Ease of use
- 16 Environmental benefits
- 17 Reliability
- 19 Nearly 50 years of Shaping Possibility

XPR overview

Unmatched performance. Unbeatable operating cost.

The new XPR300™ represents the most significant advance in mechanized plasma cutting technology, ever. This next generation system redefines what plasma can do by expanding its capabilities and opportunities in ways never before possible. With unmatched X-Definition™ cut quality on mild steel, stainless steel and aluminum, the new XPR300 increases cut speed, dramatically improves productivity and slashes operating costs by over 50%. New ease-of-use features and engineered system optimization make the XPR300 easier to run with minimal operator intervention, while also ensuring optimal performance and unmatched reliability.



Range 2 cuts on 6 mm (1/4") mild steel

Industry leading cut quality – X-Definition

The XPR advances HyDefinition® cut quality by blending new technology with refined processes for next generation, X-Definition cutting on mild steel, stainless steel and aluminum.

- Consistent ISO range 2 results on thin mild steel
- Extended ISO range 3 cut quality results compared with earlier plasma technology
- Superior stainless steel cut quality across all thickness ranges
- Superior results on aluminum using Vented Water Injection™ (VWI)

Optimized productivity and reduced operating costs

- 300 amps and 63 kW of output power deliver higher cut speeds; up to 15% on thicker materials
- Consumable life increases of over 40% compared with previous systems
- 20% thicker piercing capability on stainless steel and 30% thicker on mild steel
- Operating costs reduced by over 50%

Engineered system optimization

- Increases consumable life 3 times that of competitor's systems by eliminating the impact of ramp down errors
- Reduces the impact of catastrophic electrode blowouts which can damage the torch at high current levels

XPR cut quality comparison

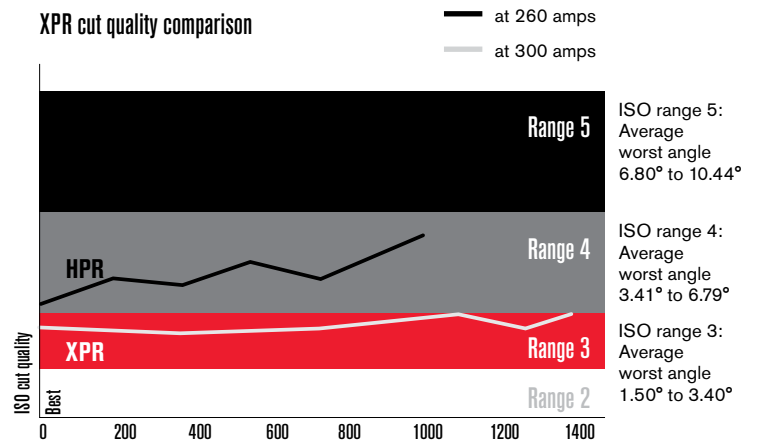

20-second cuts on mild steel

XPR300 vs. HPR260XD relative cost on 20 mm (3/4-inch)

Consumables, power and gas

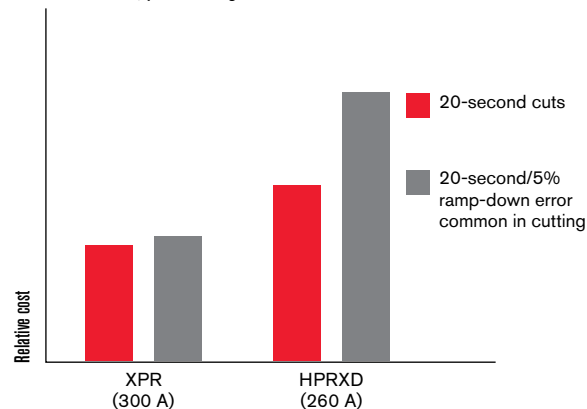

Ease of use

- Intuitive operation and automatic monitoring redefine ease of use
- Full control of all functions and settings via the CNC
- Automatic system monitoring and specific troubleshooting codes for improved maintenance and service prompts

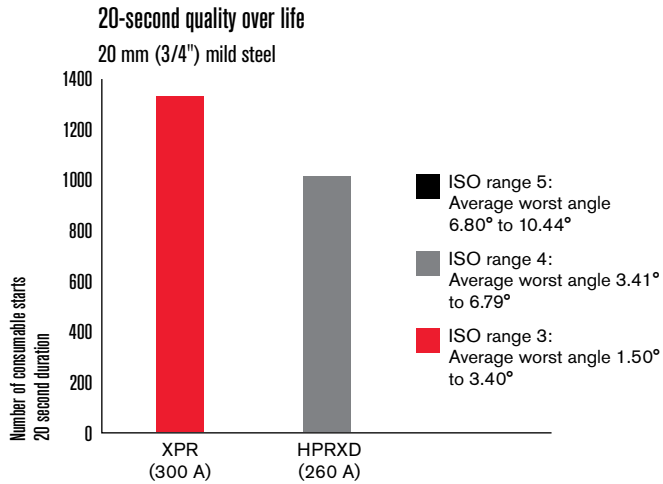

- EasyConnect™ torch lead and one hand torch-to-receptacle connection for fast and easy change-outs
- QuickLock™ electrode for easy consumable replacement
- WiFi in power supply can connect to mobile devices and LAN for multiple system monitoring and service



Industry leading X-Definition cut quality

Torch and consumable technology

X-Definition™ improves cut quality and consistency on mild steel, expands the application of Hypertherm's pioneering HyDefinition® process to a broad range of non-ferrous applications and greatly enhances it with a number of critical new cutting technologies.

Expanded HyDefinition technology

Hypertherm's pioneering HyDefinition® technology, featuring a unique two-piece vented nozzle design, aligns and focuses the plasma arc, increasing arc stability and energy density for more consistent, precise cut quality. Previously used primarily on mild steel applications, this foundational technology is now applied to the full range of non-ferrous cutting processes for cleaner, sharper, more consistent edge quality on stainless steel and aluminum.

Vented Water Injection (VWI)

This patent pending process features a vented N₂ plasma and an H₂O shield. Edges are square, angularity is reduced and surface finish is excellent on non ferrous materials, especially aluminum.



Cool nozzle

Patent pending feature on the 300-amp oxygen process provides liquid cooling directly to the nozzle bore. This cooling is a significant factor in increasing cut quality over the life of the consumables by over 40%.

Cool nozzle

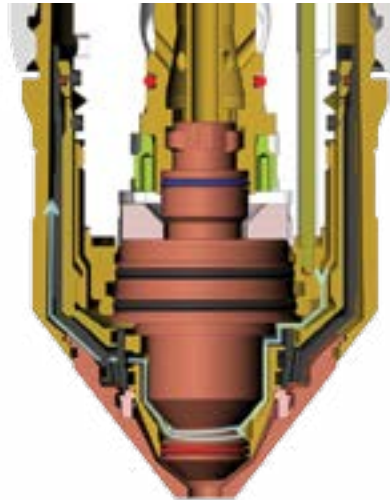

Vent-to-shield technology

This new technology mixes hydrogen reclaimed from the vented plasma gas with the shield gas to reduce angularity and deliver more consistent edge color on stainless steel up to 12 mm (1/2").

Plasma dampening

Patent pending plasma dampening delivers increased arc density and cut speeds on thin stainless while maintaining arc stability and smoother cut edges.

PowerPierce

Patented PowerPierce® liquid cooled shield technology repels molten metal during piercing allowing production piercing of 45 mm (1-3/4") on mild steel all the way up to 50 mm (2") when using Hypertherm's exclusive argon-assist process.



Advanced arc stability

Superior arc steadiness from a modified shield gas impingement improves arc stability when coming out of a pierce hole or out of an acute angle delivering reduced lead-in lengths and improved cut quality.

Improved torch geometry

Superior bevel capability and performance thanks to an enhanced tapered torch design that features a 76° included angle and bevel rotation of up to 52° .

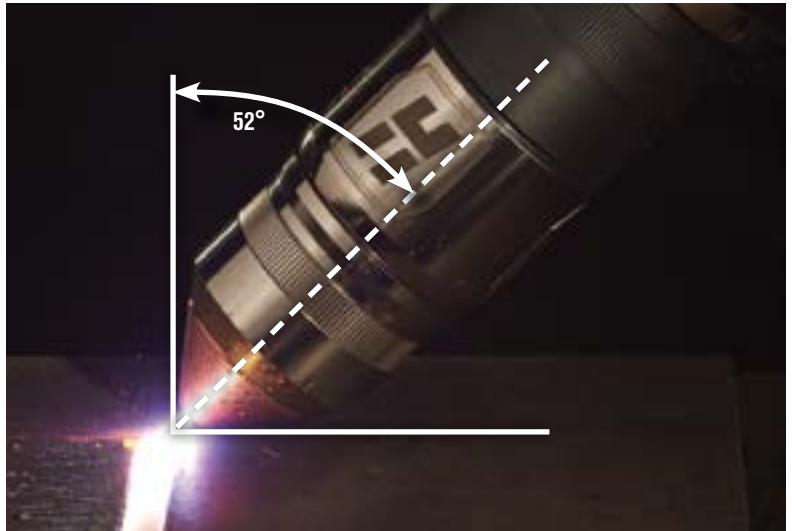

True Hole technology

XPR™ True Hole® technology incorporates new arc segmentation protocols to automatically produce bolt hole quality on mild steel with diameter to thickness ratios of 1:1 up to 2:1.



Process control and delivery.

State-of-the-art process control through a completely new concept in gas and fluid delivery. Three console options – Core™, Vented Water Injection™ (VWI) and OptiMix™ – offer unmatched mild steel cut quality with each console delivering successively enhanced cutting capabilities on stainless steel and aluminum. All consoles can be fully controlled through the CNC for high productivity and ease of use.



	Gas-connect console gases/fluids		
	Core	Vented Water Injection (VWI)	OptiMix
O ₂ /N ₂ /Air	•	•	•
F5/Ar/H ₂ O		•	•
H ₂ -N ₂ -Ar mixing			•

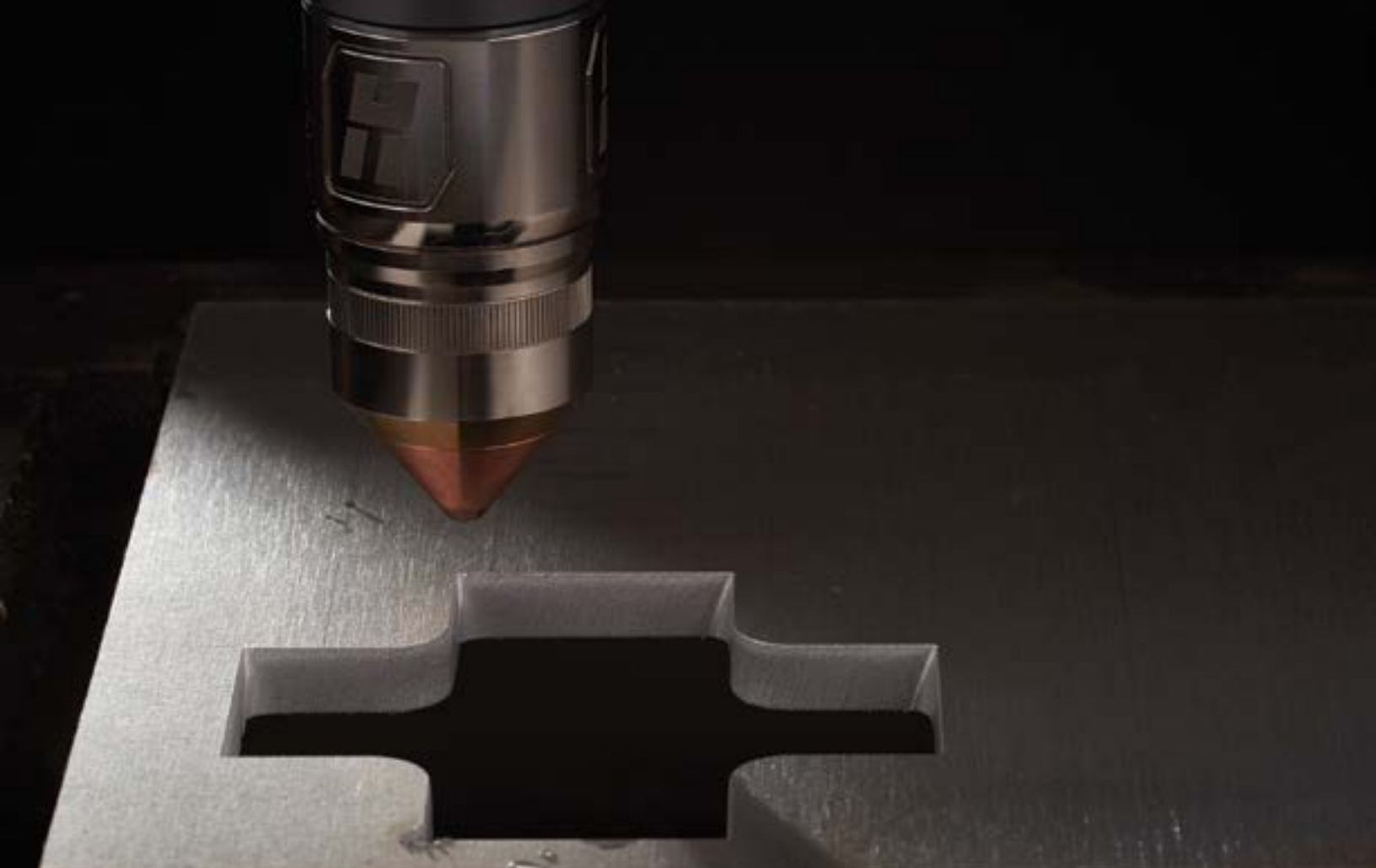

Core™ console

Unmatched mild steel cutting performance and superior angularity and edge finish on stainless steel up to 12 mm (1/2"). This is delivered through a new N₂ HDi™ process that prevents the mixing of air into the plasma gas, creating an improved, brighter edge finish.

Vented Water Injection™ (VWI) console

All Core console capabilities plus a more than 10% increase in piercing thickness with argon-assist. Significantly enhanced stainless steel and aluminum capabilities are delivered with the addition of F₅ HDi processes and patent pending Vented Water Injection (VWI).

OptiMix™ console

All the capabilities of the Core and VWI consoles plus discrete 3-gas mixing – Ar, H₂, and N₂ – for the world's most flexible, premium stainless steel and aluminum cutting capability.



Optimized productivity and reduced operating costs

Building on Hypertherm's industry-leading productivity technologies, XPR™ delivers faster cut speeds, higher quality cuts that reduce or eliminate secondary operations and increased consumable life with quicker set up time. These combine to further slash plasma system operating costs.

Technology benefits

- 300 amps and 63 kW of output power deliver higher cut speeds for superior productivity.
- A valve in the torch receptacle delivers more rapid and precise control over gas flows for significantly longer oxygen process life and a greatly accelerated ramp down process. This elimination of ramp down errors in most applications enables a consumable life span nearly 3 times longer than any other system.
- New Cool nozzle™ flow technology contributes to consumable life increases of over 40% with greater ISO range 3 results than ever before.
- Increased power and argon-assist piercing delivers 30% thicker piercing capacity on mild steel for further productivity benefits.

Number of 20-second starts with 5% ramp-down errors

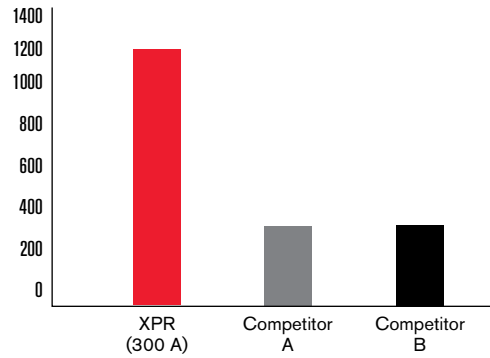

		XPR300	
Maximum output power		63 kW	
100% duty arc voltage		210 V	
Cut chart thickness		mm	inches
Pierce capacity	Mild steel (argon-assist)	50	2
	Mild steel (standard O ₂)	45	1-3/4
	Stainless steel	38	1-1/2
	Aluminum	38	1-1/2
Severance capacity	Mild steel	80	3
	Stainless steel	75	3
	Aluminum	50	2





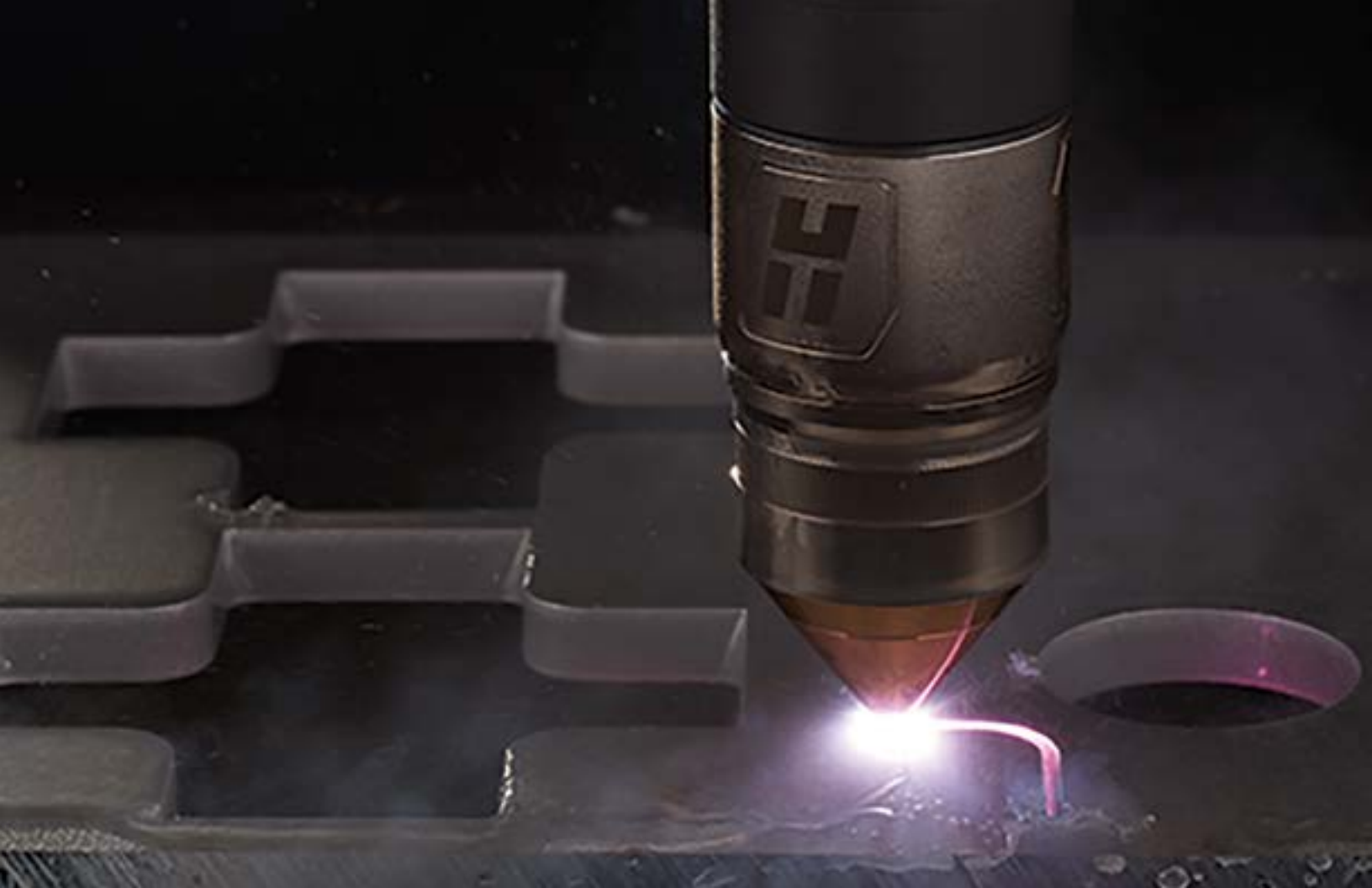

Engineered system optimization

XPR™ is engineered to deliver the highest quality cuts and optimal system performance automatically. Advanced power supply technology delivers highly responsive, rapid system feedback, and automatically intervenes to eliminate events that negatively impact system efficiency and consumable life.

Improved operating and troubleshooting information

Sensors in the power supply deliver refined diagnostic codes and significantly enhanced system monitoring information. This reduces troubleshooting time and provides proactive system maintenance data for improved system optimization.

XPR's cutting-edge power supply features advanced chopper circuitry that instantaneously senses and responds to changes in arc voltage and current settings. This sophisticated Arc response technology™ delivers important benefits that reduce operating costs and increase productivity.

Arc response technology™

Automatic torch protection

The chopper module senses the onset of catastrophic electrode blowout failure and shuts down the system, protecting the torch from potential damage and enabling improved consumable utilization.

- Prevents torch failure
- Reduces operating cost

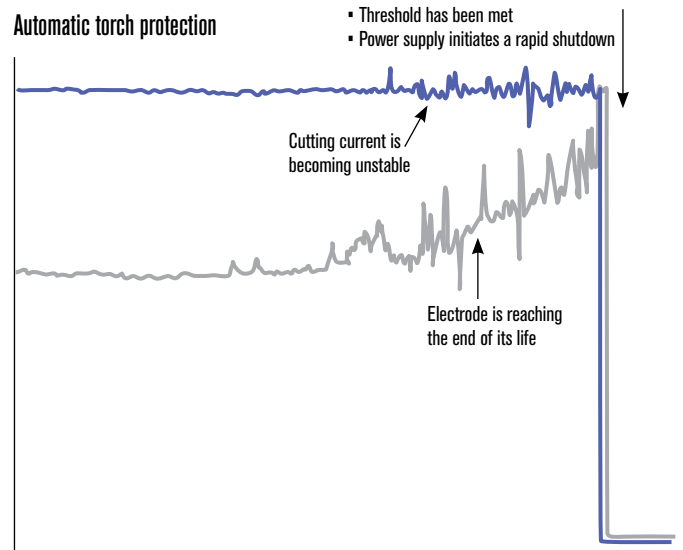

— Cutting current
— Arc voltage
— Plasma pressure

Automatic ramp-down error protection

The chopper module senses when a cut is about to end in an uncontrolled manner – without proper ramp down of current and gas flow. It automatically initiates a rapid ramp-down sequence protecting the electrode, dramatically extending consumable life – over 3 times that of systems that don't have this feature.

- Protects electrode
- Improves realized consumable life
- Reduces operating cost

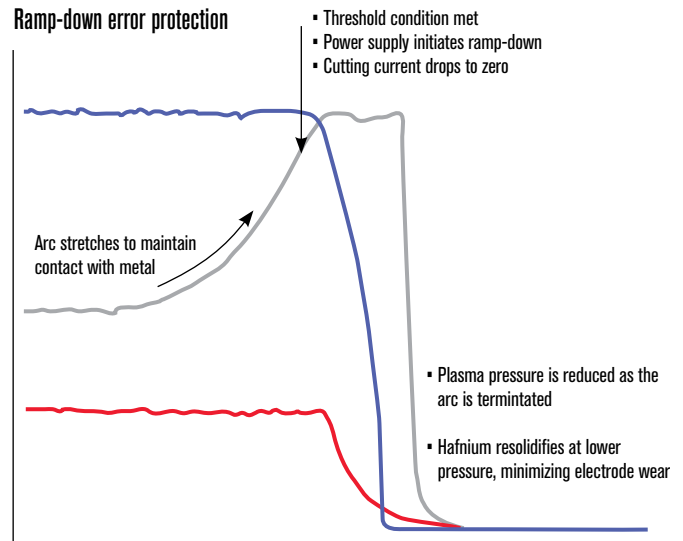



Ease of use

XPR™ sets the new standard for achieving advanced system performance easily. From system set up and installation to connectivity and process optimization, XPR's intuitive operation and automatic system monitoring redefine easy plasma cutting.

- Fewer consoles and connections reduce components and complexity.
- Torch lead includes the EasyConnect™ tool-less connection to the TorchConnect™ console, reducing set up time and simplifying replacement.

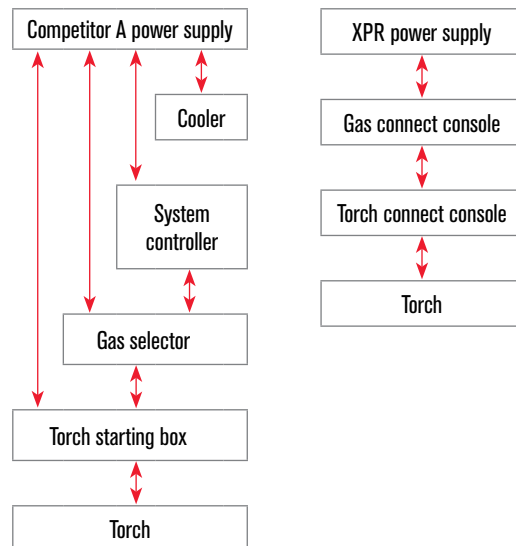

- All consoles feature advanced autogas capability enabling all cutting processes to be selected and driven directly from the CNC.
- Patent pending QuickLock™ electrode delivers easy ¼ turn tightening, reducing job setup time.
- Hypertherm's easiest and fastest torch disconnect design enables a rapid, one handed torch change.



- Built in WiFi connects operating and monitoring abilities to the mobile device dashboard.
- Easy to navigate and read.
- Allows the selection of cutting processes and the monitoring of multiple systems from most mobile devices and laptops.

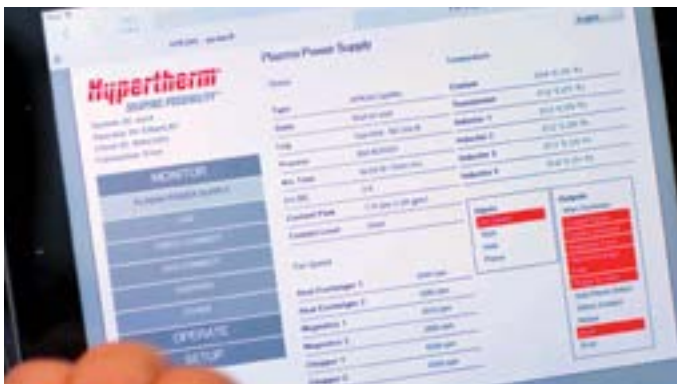

Environmental benefits

The engineering mission at Hypertherm is to develop innovative technologies, products, and solutions that provide superior value to our customers, our owners, and our planet. We consider it critical to our success to reduce the environmental impact of everything we do. The XPR300 system has been designed to be more efficient and less wasteful by reducing consumable use, energy and the carbon footprint.

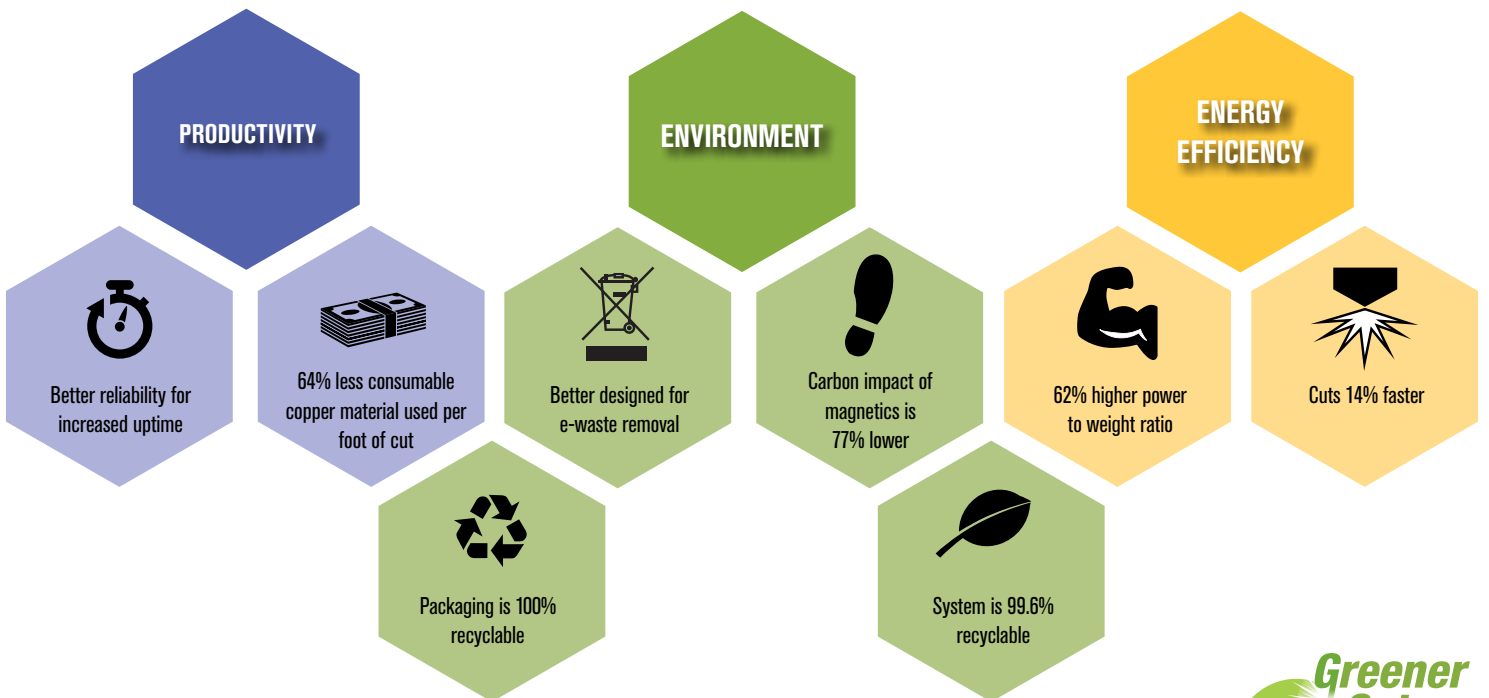

Reliability

XPR's engineering development is the culmination of tens of thousands of hours in testing, data analysis, and system tuning. Our development optimizes your uptime ensuring reliable machine performance even under highly stressful field conditions. The XPR™ is Hypertherm's smartest mechanized plasma system to date. On-board sensors continually monitor current, pressure, temperature, flow and compare to specifications during your operation to ensure optimum performance.

Specifications

General	
Maximum open-circuit voltage	360 VDC
Maximum output current	300 A
Output voltage	50 VDC-210 VDC
Duty cycle rating	100% at 63 kW, 40° C (104° F)
Operational ambient temperature range	-10° C-40° C (14° F-104° F)
Power factor	0.98 at 63 kW
Cooling	Forced air (Class F)
Insulation	Class H
EMC emissions classification (CE models only)	Class A
Lift points	Top lift eye
Bottom lift truck slots	Lift eye weight rating 680 kg (1,500 lb.)

Console	Cutting gases	Current (A)	Cut chart thickness (mm)	Approximate cutting speed (mm/min)	Cut chart thickness (in.)	Approximate cutting speed (ipm)
Mild steel						
Core, VWI, and OptiMix	O ₂ plasma O ₂ shield	30	0.5	5348	0.018"	215
			3	1153	0.135"	40
			5	521	3/16"	30
	O ₂ plasma Air shield	80	3	5582	0.105"	225
			6	3048	1/4"	110
			12	1405	1/2"	55
	O ₂ plasma Air shield	130	3	6502	0.135"	240
			10	2680	3/8"	110
			38	256	1-1/2"	10
	O ₂ plasma Air shield	170	6	5080	1/4"	200
			12	3061	1/2"	115
			25	1175	1"	45
O ₂ plasma Air shield	300	50	267	2"	10	
		12	3940	1/2"	155	
		25	1950	1"	75	
O ₂ plasma Air shield		50	560	2"	21	
		80	165	3"	7	
Stainless steel						
Core, VWI, and OptiMix	N ₂ plasma N ₂ shield	40	0.8	6100	0.036"	240
			3	2683	0.105"	120
			6	918	1/4"	32
VWI and OptiMix	F5 plasma N ₂ shield	80	3	4248	0.135"	140
			6	1916	1/4"	70
			12	864	1/2"	34
OptiMix	H ₂ -Ar-N ₂ plasma N ₂ shield	170	10	1975	3/8"	80
			12	1735	1/2"	65
			38	256	1-1/2"	10
	H ₂ -Ar-N ₂ plasma N ₂ shield	300	12	2038	1/2"	80
			25	1040	1"	40
			50	387	2"	17
VWI and OptiMix	N ₂ plasma H ₂ O shield	300	75	162	3"	6
			12	2159	1/2"	85
			25	1302	1"	50
			50	403	2"	15
Aluminum						
Core, VWI, and OptiMix	Air plasma Air shield	40	1.5	4799	0.036"	240
			3	2596	1/8"	85
			6	911	1/4"	32
VWI and OptiMix	N ₂ plasma H ₂ O shield	80	3	3820	1/8"	140
			6	2203	1/4"	80
			10	956	1/2"	28
	N ₂ plasma H ₂ O shield	130	6	2413	1/4"	95
			10	1702	3/8"	70
			20	870	3/4"	35
N ₂ plasma H ₂ O shield	300	12	2286	1/2"	90	
		25	1302	1"	50	
		50	524	2"	20	
OptiMix	H ₂ -Ar-N ₂ plasma N ₂ shield	300	12	3810	1/2"	150
			25	2056	1"	80
			50	391	2"	15

This does not represent a complete list of processes or thicknesses that are available



Nearly 50 years of Shaping Possibility

With the right tools and a relentless focus on innovation, partnership and community, we believe anything is possible.

At Hypertherm®, we give shape to our customers' vision with the world's leading industrial cutting solutions. Every day we help individuals and companies around the world envision better, smarter and more efficient ways to produce the products that shape our world. So whether you're cutting precision parts in North America, constructing a pipeline in Norway, fabricating agricultural machinery in Brazil, gouging out welds in the mines of South Africa, or building a skyscraper in China, you can count on Hypertherm to help you not just cut parts but achieve your vision.

100% employee ownership matters

At Hypertherm, we aren't just employees: we're all owners. Ownership is a powerful motivator that ensures our customers are our top priority. As owners, we make sure every product is built to the highest quality and that our service is second to none. And we build long-term relationships that deliver value for us, our partners and our customers.

Shaping what's possible the world over

Hypertherm is a key partner for your fabrication needs and has built a global organization focused on providing high-performance cutting solutions.

Key elements of the Hypertherm formula include:

- Dedicated Associates focused on customer-centered product design and support
- Local sales and service
- Broad application experience and proven results
- Sustainable and ethical business practices benefit our customers and communities

**HELPING YOU
SHAPE THE WORLD.**



PLASMA | LASER | WATERJET | AUTOMATION | SOFTWARE | CONSUMABLES

For location nearest you, visit:
www.hypertherm.com

HyPerformance, X-Definition, HyDefinition, XPR, HPR, Core, Vented Water Injection, PowerPierce, True Hole, OptiMix, HDi, Cool nozzle, Arc response technology, EasyConnect, and QuickLock are trademarks of Hypertherm Inc. and may be registered in the United States and/or other countries

One of Hypertherm's long-standing core values is a focus on minimizing our impact on the environment. Doing so is critical to our, and our customers' success. We are always striving to become better environmental stewards; it is a process we care deeply about.



© 2/2017 Hypertherm Inc. Revision 0

897060

Hypertherm[®]
SHAPING POSSIBILITY™

